

# Installation instruction

## Meanwell LCM40



The Mymesh Meanwell LCM40 is a product in the Chess program for building light control. The Meanwell LCM40 is a power supply for wireless control of LED lamps and automatically forms a wireless network with the surrounding Mymesh products.

### Safety



- Installation and service should be performed by qualified personnel only.
- The electrical installation must be in conformance with the national legislation and relevant standards.
- The mains connection of the Meanwell LCM40 must be provided with a fuse or circuit breaker.
- Disconnect power at the source before installation, inspection or removal.
- Do not use the Meanwell LCM40 if it is damaged.
- The Meanwell LCM40 is suitable for use at indoor locations (IP20 protection class). Mount the Meanwell LCM40 in an IP66 housing for use at outdoor locations.

### Application

Refer to the Meanwell LCM40 product sheet (see [chess.nl](http://chess.nl)) for the environmental conditions.



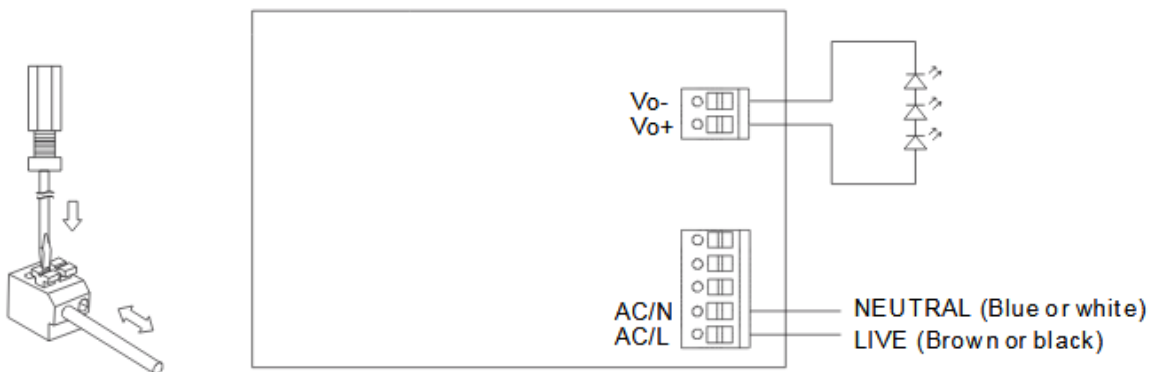

## Installation

- Mount the Meanwell LCM40 in the direct neighborhood of other Mymesh products.
- The Meanwell LCM40 contains an antenna for wireless communication with other Mymesh products. Operation of the antenna should not be disrupted.
  - Ensure that the antenna (top side) is pointing upright.
  - Do not mount the Meanwell LCM40 inside a metal housing or directly next to a large metal object.
  - Some glass and plastic materials influence the operation of an antenna.
  - Contact Chess in case of doubt.
- Connect the LED lamp to Vo- and Vo+ and connect the mains power to AC/N and AC/L (see schematic below).

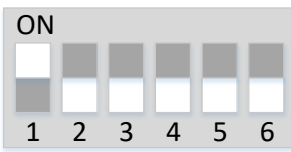

## Configuration

The output current of the Meanwell LCM40 can be adjusted to various settings by means of a DIP switch (see table below).

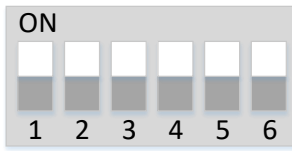
Voltage range	Selectable current	DIP switch setting <sup>1</sup>	Voltage range	Selectable current	DIP switch setting <sup>1</sup>
2-100 V	350 mA	ON 	2-57 V	700 mA	ON 
2-80 V	500 mA	ON 	2-45 V	900 mA	ON 
2-67 V	600 mA	ON 	2-40 V	1050 mA	ON 

(1) the white square indicates the position of the DIP switch

Configure the Overvoltage protection (OVP) set point with the Mymesh commission app for correct fault detection in a back office.

Current	OVP setpoint
700/900/1050 mA	Low
350/500/600 mA	High

When the Meanwell LCM40 is powered, the connected lamp should go on. Use the iPad Mymesh commission app for configuration of the Meanwell LCM40.

## Usage

The Meanwell LCM40 will control the connected LED lamp and adjust it to the required light level.

## Compliance



This product complies with the European directives and relevant standards for RED, REACH and RoHS. The Meanwell LCM40 contains a 2.4 Ghz radio. The applied frequency of the radio is within the band 2.401 – 2.482 GHz and the maximum transmit power is +4 dBm.

Hereby, Chess Wise B.V. declares that the radio equipment type Mymesh Meanwell LCM40 is in compliance with Directive 2014/53/EU. The full text of the EU declaration of conformity is available at [chess.nl](http://chess.nl)

## Repair

Do not open this product. In case of failure the Meanwell LCM40 must be replaced.

## Recycling



Do not dispose this product as household waste, but bring it to an appropriate collection point for recycling.